

LOKI

DAN DRYER A/S
Tåsingevej 2
DK-8940 Randers SV

+45 86 41 57 11
info@dandryer.com
dandryer.us



DISTINCTIVE FEATURES AND CLEAN LINES





The LOKI line derives from DAN DRYER's established design tradition where design, functionality and quality go hand in hand.

The vision has been to create a beautiful and functional design, which complements the surrounding architecture. To ensure this, the design is characterized by clean lines and shapes that harmonize with the surrounding architectural elements such as windows, doors, and wall surfaces.

Repetition as a key word in this award-winning product line. The characteristic line on the case front ties together the product line and creates harmony when LOKI products are displayed side by side.



LOKI IS AVAILABLE IN

- BLACK 
- WHITE 
- STAINLESS STEEL 
- OPTIONAL CLASSIC RAL COLOR 

SOAP/DISINFECTANT DISPENSERS

Touch-free

- Available for foam soap, liquid soap, and disinfectant (8.5 dl)
- Refillable container
- Battery-operated or connected to a power outlet via a transformer
- Drip tray not included
- Dimensions: H: 11.81", W: 6.81", D: 4.01" (excl. drip tray)
- For wall-mounting or attached to a freestanding floor or desk stand
- Available in powder coated stainless steel, matte black, white and custom RAL colors
- 2 year warranty

Manual

- Available for foam soap, liquid soap, and disinfectant (6 dl)
- Refillable container
- Dimensions: H: 12.91", B: 5.15", D: 4.52"
- Available in powder coated stainless steel, matte black, white and custom RAL colors
- 2 year warranty

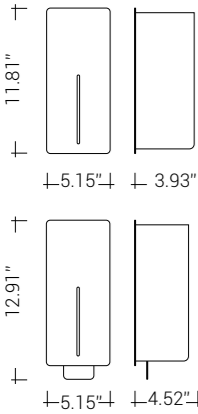



HAND DRYERS

- Drying cycle of 10-15 seconds
- Total effect: 840-1000W
- LED light indicates when the machine is in use
- Adjustable sensor range and motor speed
- Available in powder coated stainless steel, matte black, white and custom RAL colors
- 5-year warranty

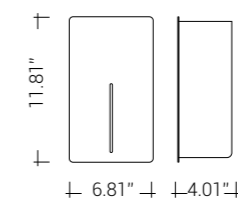



SOAP/ DISINFECTANT DISPENSERS

PAPER TOWEL DISPENSERS



HAND DRYERS

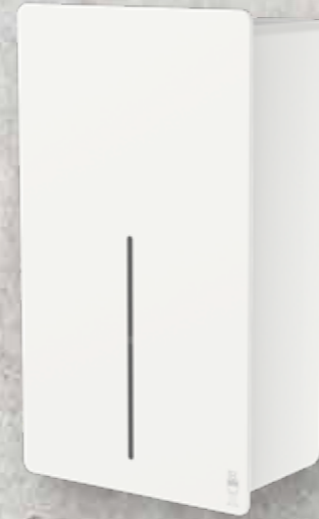

FLOOR & TABLE STANDS



TOILET ROLL HOLDERS



WASTE BINS

SANITARY BINS



TOILET ROLL HOLDERS

Double

- Capacity: 2 standard size paper rolls
- Ideal for low to medium traffic washrooms
- The paper refill level is visible through the front cover
- Available in powder coated stainless steel, matte black, white and custom RAL colors
- 2-year warranty

Jumbo

- Capacity: 1 jumbo roll
- Ideal for high-traffic restrooms
- The paper refill level is visible through the front cover
- Available in powder coated stainless steel, matte black, white and custom RAL colors
- 2-year warranty

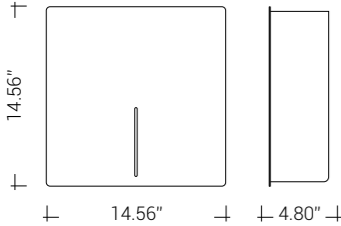
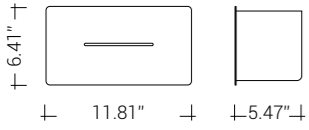

PAPER TOWEL DISPENSERS

- Fits z-folded paper towels
- The paper refill level is visible through the front cover
- Available in powder coated stainless steel, matte black, white and custom RAL colors
- 2-year warranty

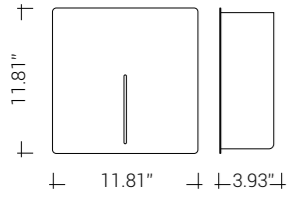

WASTE BINS

LOKI

- Capacity: 23 L
- Open throw-in
- Interior bag holder
- Available in powder coated stainless steel, matte black, white and custom RAL colors
- 2-year warranty

LOKI MAXI

- Capacity: 30 L
- Open throw-in
- Interior bag holder
- Available in powder coated stainless steel, matte black, white and custom RAL colors
- 2-year warranty

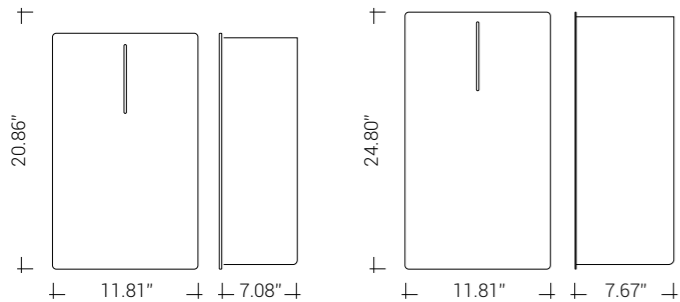

SANITARY BINS

- Capacity: 3 L
- Pivoting front plate
- Interior bag holder
- Available in powder coated stainless steel, matte black, white and custom RAL colors
- 2-year warranty

- Capacity: 11 L
- Pivoting front plate
- Interior bag holder
- Available in powder coated stainless steel, matte black, white and custom RAL colors
- 2-year warranty

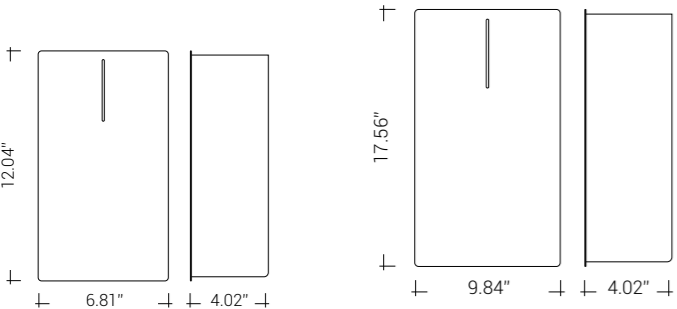

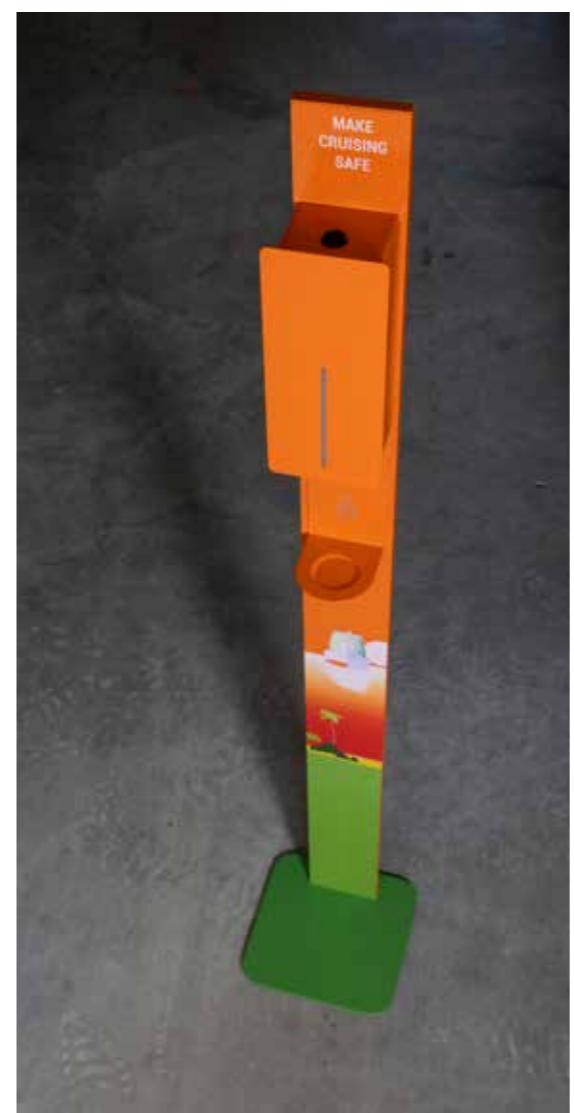

MIRROR

- 39.37" x 19.68"
- Versatile hanging options. Horizontally or vertically
- Suited for entryways, bedrooms, or bathrooms
- Timeless design which complements any interior decor
- Available in matte black, white, or RAL classic color
- Can be combined with all DAN DRYER product lines: BJÖRK, LOKI, TAPS, and Stainless Design
- 2 year warranty



19.68"

39.37"



GRAB BARS

- Available in 4 sizes; 18", 24", 36", 42"
- Enhance and ensure accessibility and stability for everyone
- Available in matte black, white, or RAL classic color
- Can be combined with all DAN DRYER product lines: BJÖRK, LOKI, TAPS, and Stainless Design

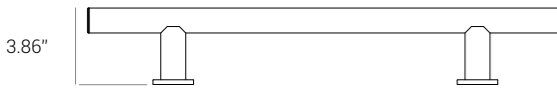
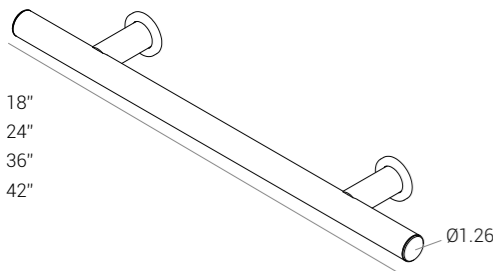

COAT HOOK

- Available in 2 sizes; single or double
- Suited for offices, entryways, bedrooms, or bathrooms
- Back-to-back mounting option
- Sleek design
- Available in matte black, white, or RAL classic color
- 2 year warranty

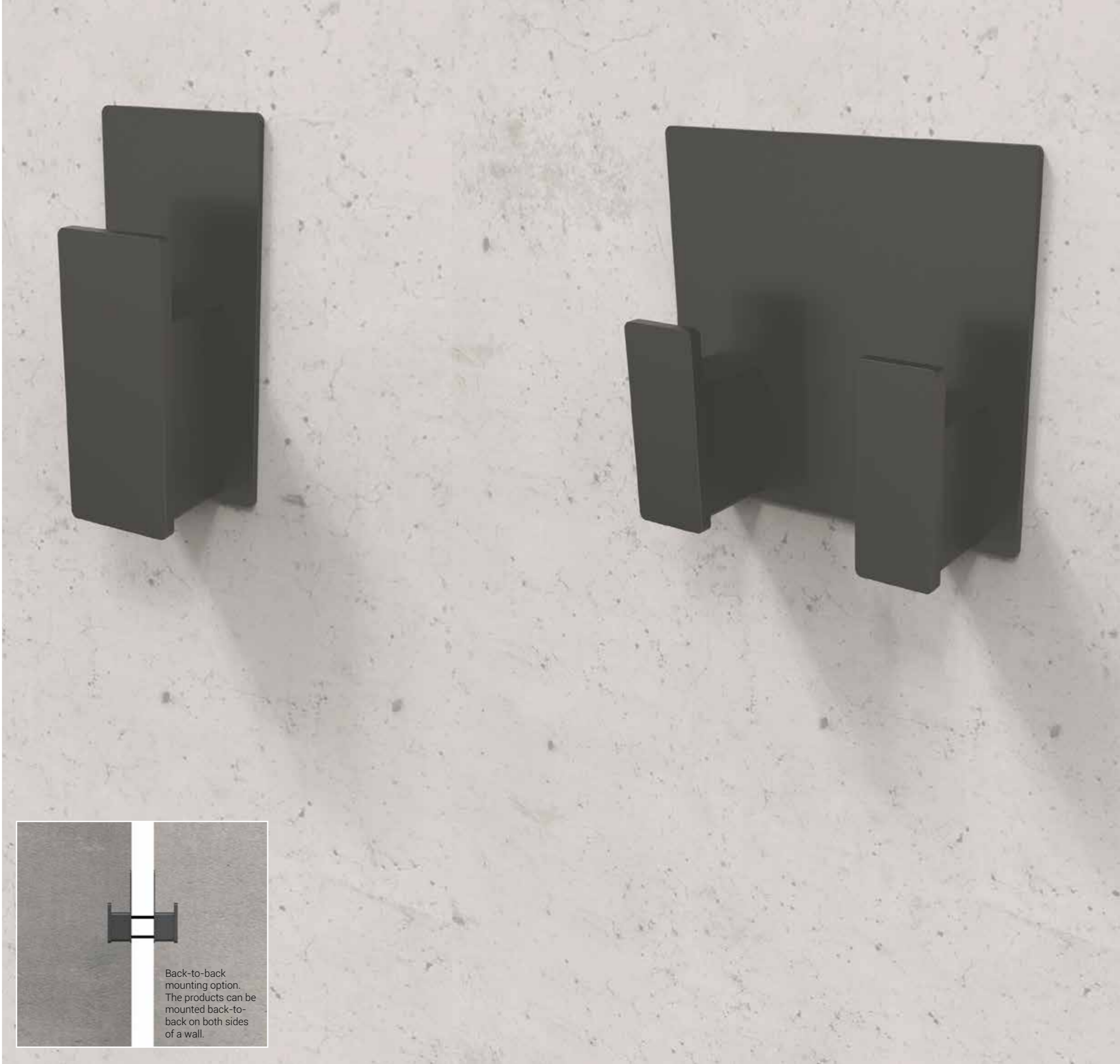
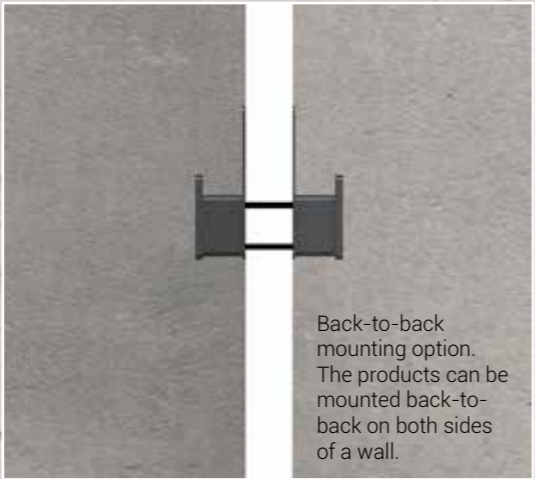
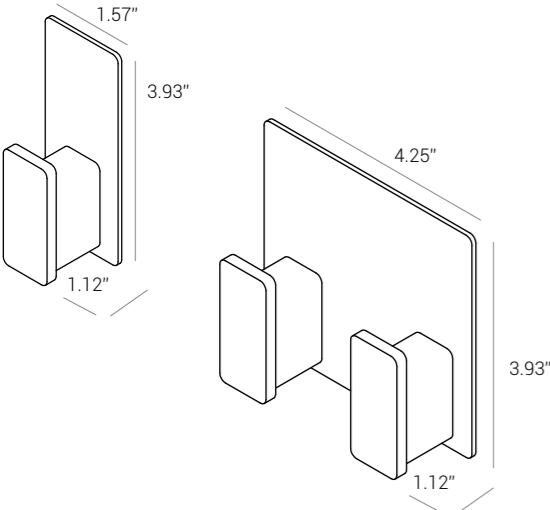
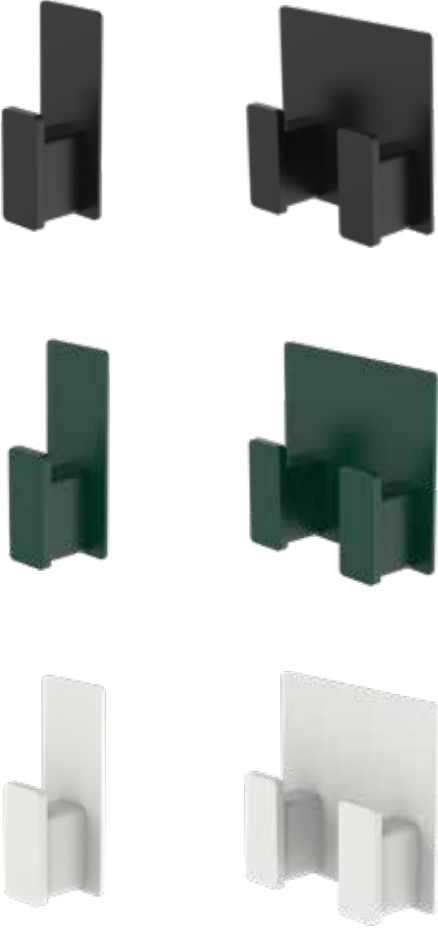

TOILET ROLL HOLDER

- Capacity: 1 standard size paper roll
- Ideal for low to medium traffic restrooms
- Back-to-back mounting option
- Sleek design
- Available in matte black, white, or RAL classic color
- 2 year warranty

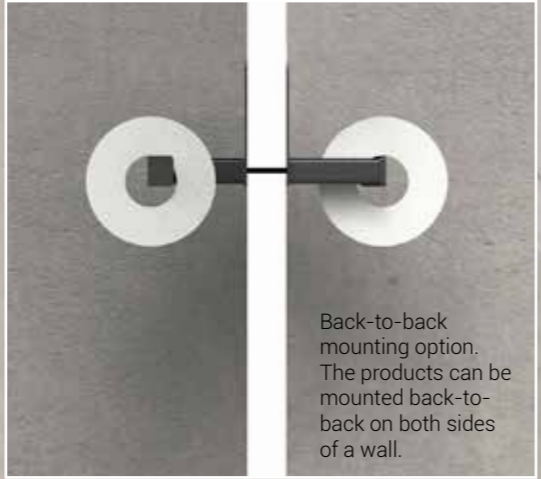
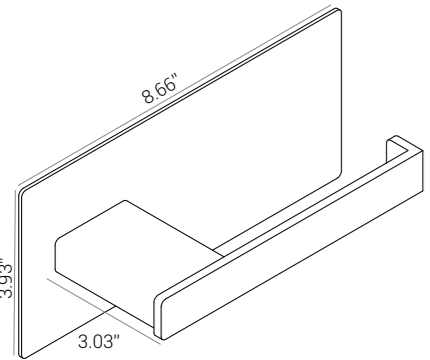
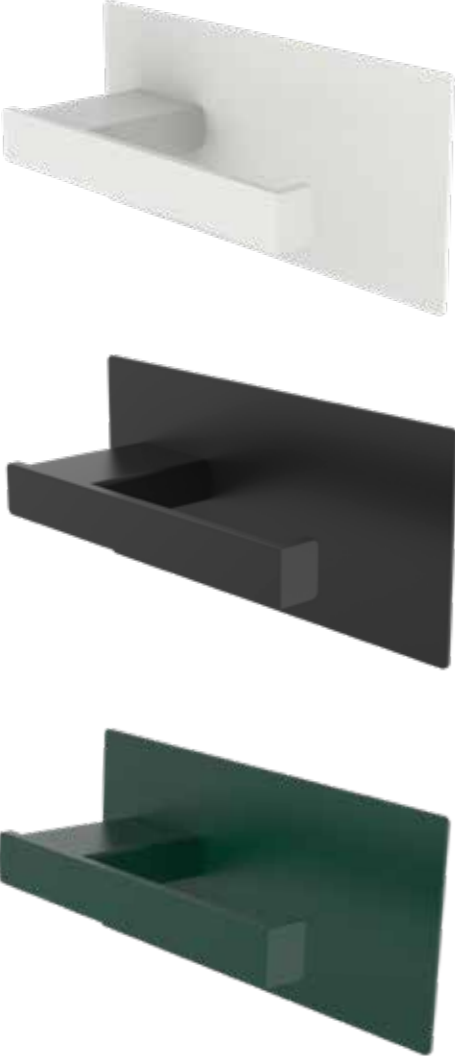

Back-to-back mounting option. The products can be mounted back-to-back on both sides of a wall.



TOILET ROLL HOLDER W/ TOP

- Capacity: 1 standard size paper roll
- Ideal for low to medium traffic washrooms
- Back-to-back mounting option
- Sleek design
- Available in matte black, white, or RAL classic color
- 2 year warranty

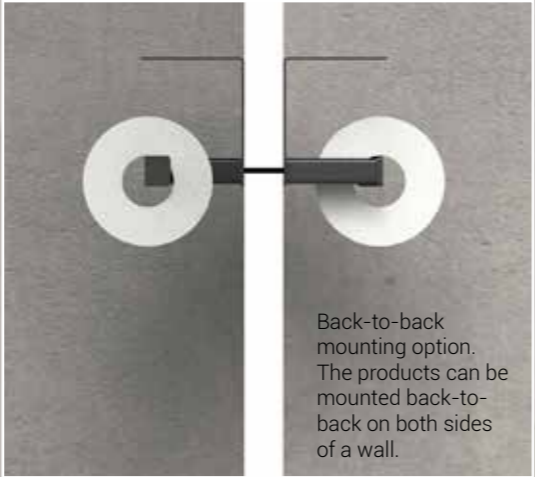
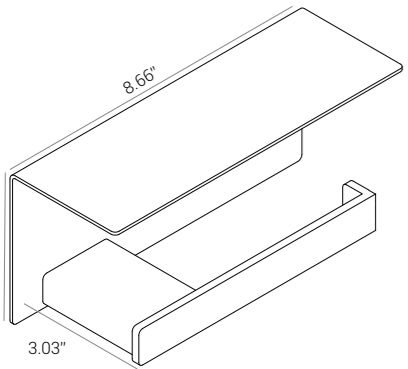
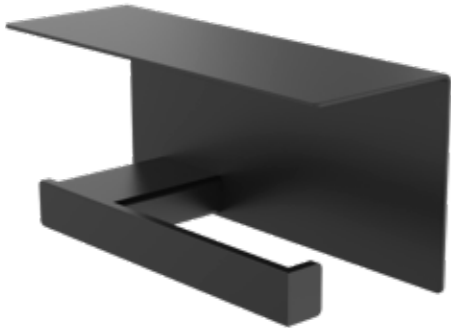

Back-to-back mounting option. The products can be mounted back-to-back on both sides of a wall.

TOILET ROLL STORAGE HOLDER

- Smart toilet roll storage holder that allows storage of a spare roll within reach
- Capacity: 1 standard size paper roll
- Ideal for low to medium traffic washrooms
- Back-to-back mounting option
- Sleek design
- Available in matte black, white, or RAL classic color
- 2 year warranty

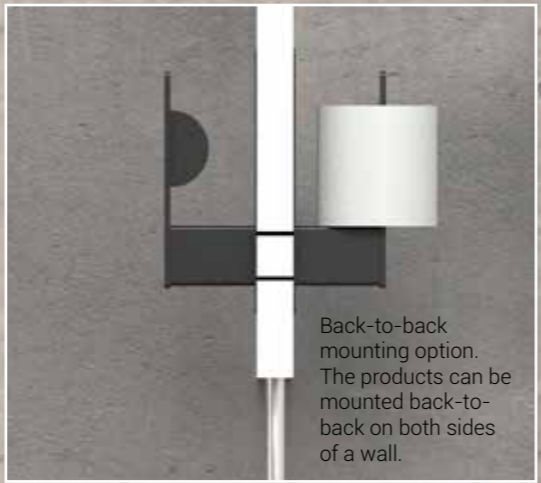
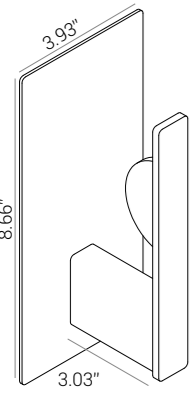
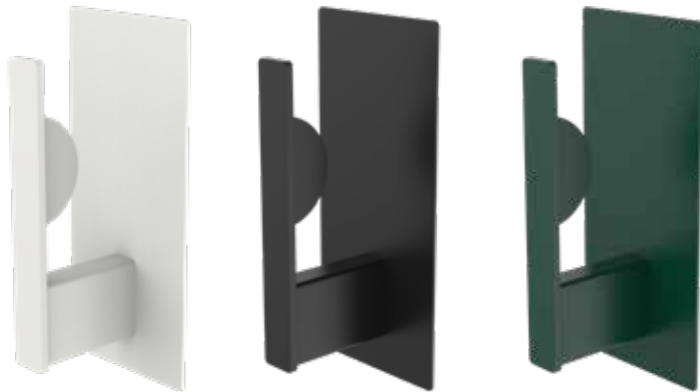

BACK-TO-BACK MOUNTING OPTION

The back-to-back mounting option is a smart and space-saving solution that maximizes efficiency and optimizes the utilization of available space.

By mounting products on both sides of a wall you get numerous advantages.

Space is a valuable commodity in any environment, whether it's a public or commercial space. The back-to-back mounting option allows for the consolidation of products on a single wall, effectively doubling the functionality without occupying additional space. This is particularly beneficial in compact areas where every inch counts.

Moreover, this mounting method damages the walls less and enhances the aesthetics of the space by eliminating clutter and providing a clean and streamlined appearance.

With products neatly arranged on both sides of the wall, the overall visual impact is organized and visually appealing. This not only contributes to a more polished and professional look but also creates a more pleasant and conducive environment.







INTERNATIONAL AWARDS

LOKI PRODUCT LINE

- Red Dot Design Award – Product Design 2021

LOKI HAND DRYER

- German Design Award 2021
- German Innovation Award 2021
- German Brand Award 2021
- GOOD DESIGN 2021

LOKI DISPENSER ON FLOOR STAND

- German Design Award 2021
- iF DESIGN AWARD 2021
- German Innovation Award 2021
- GOOD DESIGN 2021



reddot winner 2021

